



LA-E4S

Operation Manual



Hangzhou Bingjia Tech. Co., Ltd.

www.lockedair.com.

Abstract

Thank you for using LockedAir air cushion system. To ensure that you use the equipment correctly, be sure to read the instructions before you operate it!

Note: Operation of different models are slightly different, please pay attention to the tips mentioned below.

Warning

- a. Power supply to machine must be consistent with the parameters on the machine nameplate, to prevent damage to the machine, please use only the power cable provided with the product.
- b. Make sure that the power cable is reliably grounded.
- c. Only trained person can open the back cover of the machine.

Security Matters

- a. It is strictly prohibited to touch the high temperature warning area during the operation or within 5 minutes after the machine has been stopped.
- b. When the machine is working, do not touch any rotating parts.
- c. In the event of the following emergency, press the power switch quickly to cut off the total power supply of the machine.
 - The air cushion film or other material rolls into the machine and the machine does not work properly.
 - Abnormal sound inside the machine.
 - Abnormal heating, temperature on the plastic surface is too high;
 - Other exceptions

1. Main parameters of the device

Item #	Name	Parameters
1	Power	See details on nameplate
2	Rate	380W
3	Maximum production speed	18m/min (45inch/min)
4	Dimensions	300mmx360mmx345mm
5	Net weight	8.8kg(19lb)
6	Working environment temperature.	0 to 40℃(32 to 104°F)
7	Working environment humidity.	20 to 90% RH

2. Operation Manual

2.1 Operating Procedures

2.1.1 Power on

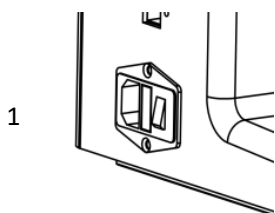

- Plug the power supply to a ground-protected single-phase three-wire socket.
- Turn on the power switch 1.

2.1.2 Load the air cushion film

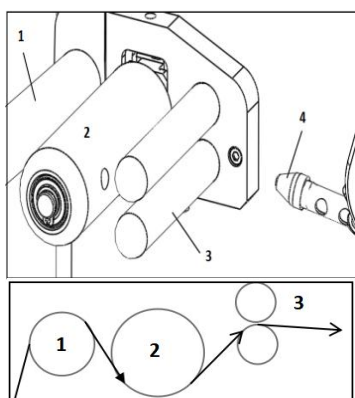

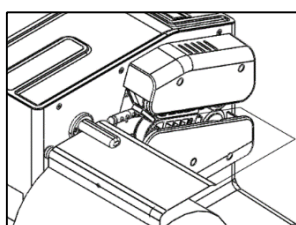

Feeding tips

- Put the paper-plastic film on the roller shaft of the machine, and the inflation port is close to the machine, as shown in the figure: the paper-plastic film passes over the top of the guide rod 1 and then under the guide rod-2, and then passes through the middle of the two positioning shafts-3, put the opening of the paper-plastic film on the outer end of the blowing pipe-4, and drag the film in the direction of the arrow to make it close to the gap between the upper and lower heating belts;



- When the machine is in a stop state, press the loading button 9  to enter the film-loading mode, at this time the upper and lower belts will pull the air cushion film slowly forward to a certain distance and then stop automatically.

Tips:

- Press loading button 9  again under the loading mode ,belt will stop rotating and exit loading mode.
- Long press the loading button 9 , the heating belt will keep running until the button is released.
- When you press the start button 12  to start the machine, you will exit loading mode.

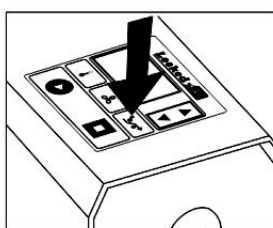

2.1.3 Parameter setting

Parameters Settings include temperature, air volume, speed and operating mode settings. In general, the parameters have been set before leaving factory. However, if you need to change the parameters, please refer to section 2.2 content.

2.1.4 Start and Stop

- Start** Press start button 12  and the heating wire heats up. This process lasts 5 ~10s, depending on the

environment temperature. The device starts after the temperature reaches the set value.

b. **Stop** Press Stop Button 10 , Machine Stops, Heating Wire cools down.

Note: Do not touch any high temperature area and rotating parts of the machine during operation or within 5 minutes after the machine stops.









2.1.5 Power off

a. When the machine is in stop state, rip off the film close to the machine.

b. Long press the film loading button 9  to drain the air cushion film that remains in the machine.



c. Turn off power switch 1.



2.2 Control panel Instructions;

	Item#	Name.	Remark
	7	Increase button	
	8	Decrease button	
	9	Film loading	
	10	Stop button	
	11	Air volume button	
	12	Start button.	
	13	Temperature button	

2.2.1 Main interface





The control panel displays as left picture when power on. The middle of screen shows current working mode,  means the heating status,  means working status,  means film loading status.

The upper left interface indicates that the machine is stopped, press start button 12 , machine displays the bottom left interface, start heating, machine starts to work when  is full, and  arrow starts to move.

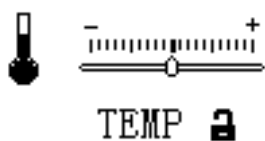
2.2.2 Set the temperature





Press temperature button 13 , and enter temperature setting interface, press increase button 7  or decrease button 8  can increase or decrease the temperature under this interface.

Note: thicker font is system default, same as below.

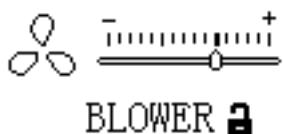
2.2.3 Set the air volume





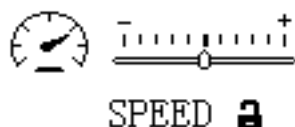

Press air volume button 11 , and enter air volume setting interface, press increase button 7  or decrease button 8  can increase or decrease the air volume under this interface.

Note : machine with external pump does not support this operation.

2.2.4 Set the speed





Press temperature button 13  and decrease button 8 , and enter speed setting interface, press increase button 7  or decrease button 8  can increase or decrease speed under this interface.

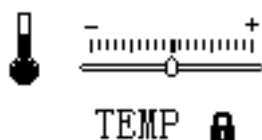

2.2.5 Parameter locking function

Locking function is available on the parameter of temperature, air volume and speed, which can be used to avoid wrong parameter due to incorrect operation.

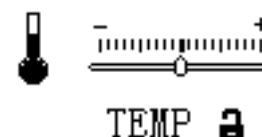

As shown in upper left figure, the “Lock” icon () displayed in parameter interface indicates that, this parameter has been locked already, and it is invalid to press “Increase” button 7  or “Decrease” button 8  at this time.





Unlock : After the parameter was locked, press “Stop” button 10 , you will hear continuous bumming, continue to press this button until the icon become , the parameter will be unlocked. Loose “Stop” button 10  to change this parameter.

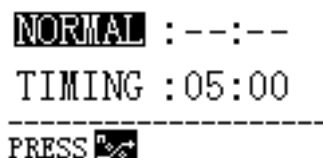

Lock: Press “Stop” button 10  in the parameter interface for a long time can lock the parameter manually. Or the machine will lock up automatically after a period of no button operation, parameters can not be set after being locked.

2.2.6 Set up Operation Mode



a. Press “Air volume setting” button 11  and “Decrease” button 8  in the main interface simultaneously to enter into selection interface of operation model.

b. Press “Trans-film” button 9  to shift from “Continuous model” to “Timing model”.





c. If selected “Timing model”, click or press “Increase” button 7  or “Decrease” button 8  for a long time enables to set the duration of timing.

d. After selected the operation model, press “Stop” button 10  to exit.



2.2.7 Select sizes

1. MEX - H - 40 - 20 - 10.0
2. MEX - H - 12 - 22 - 11.0
3. MEC - DH - 13 - 23 - 12.0
4. MFC - L - 14 - 24 - 13.0

a. Press “Air volume” setting button 11  and “Decrease” button 7  simultaneously to enter into the interface of specification selection. Different specifications can be shifted by pressing “Increase” button 7  or “Decrease” button 8  for about 3 seconds, then the corresponding selected parameter will be displayed on the right side of interface and become valid immediately.



b. After selected the specification, press “Stop” button 10  to exit such interface, then the machine will run according to the selected parameters.

Note : Specification is only required to be changed when change the size of air cushion file. Do not change the parameter at random in any other cases.

2.2.8 Auxiliary Function



In main interface, when the machine is stopped:

a. Click “Trans-film” button 9 , the temperature of machine will not be increased, but the heating belt will run for trans-film assistance. After a certain length of film has been transported, the heating belt will be stopped automatically. Or you can click the “Trans-film” button 9  again to stop the machine manually.

b. Press the “Trans-film” button 9  for a long time, the temperature of machine will not be increased, but the heating belt will run continuously. Loose this button, the machine will stop, and the residue air cushion film can be exhausted from machine.

3. Fault analysis and diagnosis.

3.1 Common faults and troubleshooting



Item #	Issue	Cause analysis	Suggested solution
1	Seal Leakage.	Heating temperature is too low.	Raise the temperature setting.
2	Seal area is thin and easy to tear.	Heating temperature is too high.	Lower the temperature setting.
3	The air volume is low.	The amount of wind is too small.	Increase the air volume setting.
4	Film break or film cut blurs	The blade is worn out.	Replace the blade.



4. Engineering Interface Operation Instruction

4.1 First-level Engineering Interface Operation

1. MFB-B-11-21-10.0
TMP:230 F-BROKEN:OFF
BLW: 20 PRA-LOCK:ON
SPD: 100 TMP-A.A. : AT



1.MFB-B-11-21-10.0—APPLICABLE SPECIFICATION ;
 TMP—TEMPERATURE ; BLW— BLOWING VOLUME ; SPD—SPEED
 F-BROKEN—FILM-BROKEN ALARM ; PRA-LOCK—PARAMETER LOCKING
 FUNCTION TMP-A.A—TEMPERATURE AUTOMATIC CORRECTION FUNCTION

In the main interface state, press the temperature setting button 13 、blowing volume button 11  and up arrow 7  at the same time, enter the engineering interface;

a.Use the blowing volume key 11  and the film loading key 9  move the cursor to select the parameters to adjust;

b.Click or long press the increase key 7  and the reduce key 8  Resize the value or select ON/OFF;

c.ON=TURN ON, OFF=TURN OFF;

d.Use the cursor to select the applicable specifications, and long press the increase key 7  and the reduce key 8  about 3 seconds, You can go to the next set of specification parameter settings;

e.In the engineering interface, select the temperature automatic correction

item **TMP-A.A.**: Including three values:

OFF (default) : Completely closed without correction

MT: Continuously open, no automatic switching correction mode for room temperature

AT: Automatic state, when the room temperature is $\leq 5^{\circ}\text{C}$, it will enter the 'cold state', and it will be displayed on the home page; when the room temperature is $> 8^{\circ}\text{C}$, it will enter the 'normal temperature state'. Press the stop key 10  to exit the interface

MFB—BUBBLE PILLOW CODE; B—BUBBLE PILLOW MATERIAL; 11—BUBBLE PILLOW THICKNESS (um) ;



21—BUBBLE PILLOW WIDTH (mm) ; 10.0—BUBBLE PILLOW LENGTH (mm)

T.Re: Temperature display correction value, Correction range 0~99 (Actual temperature = display temperature + correction value)

S.Sp: Motor stop time, default is 7; (Note: No adjustment is recommended without professional guidance)

MFB - B-11-21-10.0

T.Re : 0 S.SP : 7

a、 Use the blowing volume key 11  and the film loading key 9  move the cursor to select the parameters to adjust;

b、 Click or long press the increase key 7  and the reduce key 8  to adjust the parameters;

c、 Temperature display correction function: display the same temperature parameter value when different devices operate;

d、 Press the stop key 10  to exit the interface;

5. Transportation and Storage

1. No severe vibration and shock is allowed during transportation.
2. Do not expose the machine directly under the sun or in rain. The machine shall be stored at the environment with the temperature range $-25\sim+55^{\circ}\text{C}$ ($-13\sim131^{\circ}\text{F}$) and with the relative humidity less than 90%RH.

6. Appendix.

6.1 Replace heating belts

1. Remove the upper and lower cover.

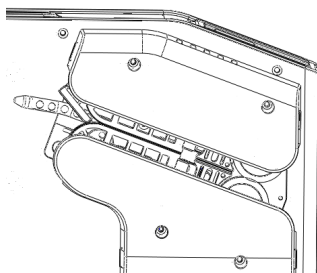

Loosen the 4 screws located on the upper and lower covers with a 3mm wrench and remove the upper and lower covers (2 on the upper cover and 2 on the lower cover).

2. Lift the press wheel.

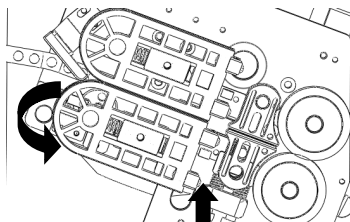

- Turn the lower heating wire assembly counterclockwise to the defined position and dial the pull ring clockwise to separate the two silicone wheels.

3. Replace the belt

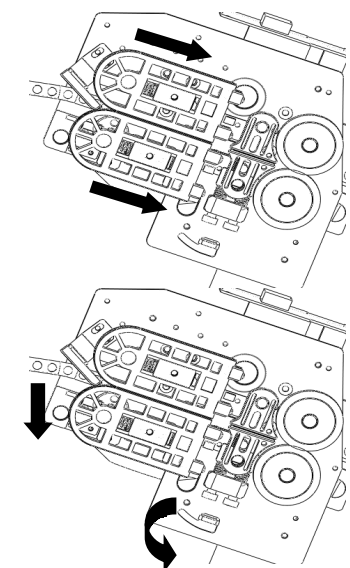

- Follow the arrow direction to push the upper heating wire mounting plate to the right, remove the heating belts from the right side, remove another heating belt in the same way.
- Load the new heating belt from the left and press to the heating belt block to install the heating belt. Install another one in the same way.
- Push lower heating wire assembly along the direction of the arrow to loosen the pull ring, dial the pull ring to reset the lower heating wire assembly

4. Install the upper and lower cover

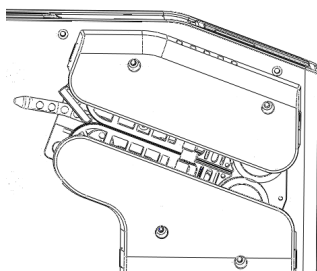

- Use a 3mm hex wrench to install the upper and lower cover with the 4 screws.

6.2 Replace the blade

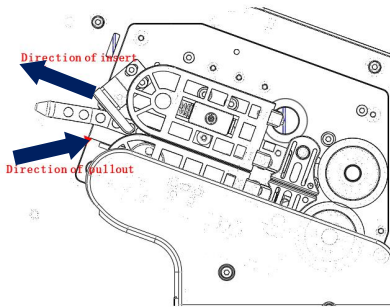

- Loosen the blow nozzle fixing screw (no need to fully unscrewed), holds the end of the nozzle to pull it out in the direction of the arrow.
- Remove the blade screw, replaces the new blade (the blade is facing outwards), and tight the blade with screw (**Caution: Not to be cut by the blade**).

Push nozzle to the right in the direction of the arrow until the nozzle cannot move, fix the assembly with screw.

6.3 Replace the high temperature adhesive tape.

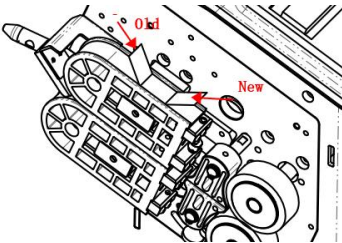

- Remove the heating wire assembly, be careful not to lose the small spring.
- Turn the upper heating wire assembly out for an angle to replace the adhesive cloth.
- Tear off the original high temperature adhesive tape by a part and then apply the new tape.